



Energyled

6F.,NO.542-4,Zhongzheng Rd ., Xindian Dist.,
,New Taipei City 231,Taiwan (R.O.C)
TEL : 886-2-7729-0589
FAX : 886-2-7729-1871
<http://www.energyled.com>

SPECIFICATION

PART NO. : BA15xBTTWxx01

調焦式軌道燈

ZOOM-ABLE TRACK LIGHT

通過 CNS14115/CNS14335 產品認證

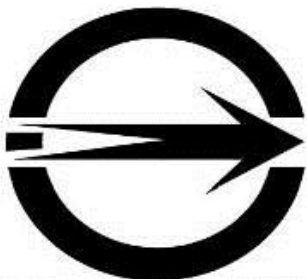

Approved by

Checked by

Prepared by

Gary

Tony shen

Jason lee



Part Number Information(型號編碼原則):

BA15 x BTTW x x xx

Color:

色溫:

S:2700K

W:3000K

T:4000K

D:5000K

C:5700K

N:6500K

Lamp Color:

燈具顏色:

0: 白色(White)

1: 黑色(black)

Focus ring Color:

調焦環顏色:

2: 銀色(silver)

Serial number:

流水號:

Dimensions(尺寸):

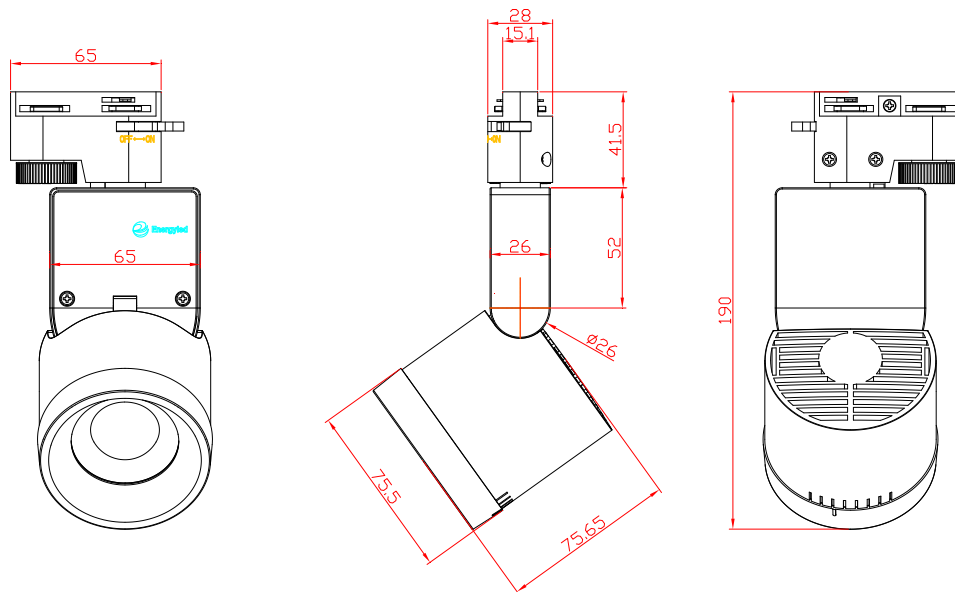

1. All dimensions are in millimeters.
所有尺寸均以毫米為單位
2. Tolerance is ± 2 mm unless otherwise noted.
除非另有說明，公差為 ± 2 毫米。



Photo(照片):

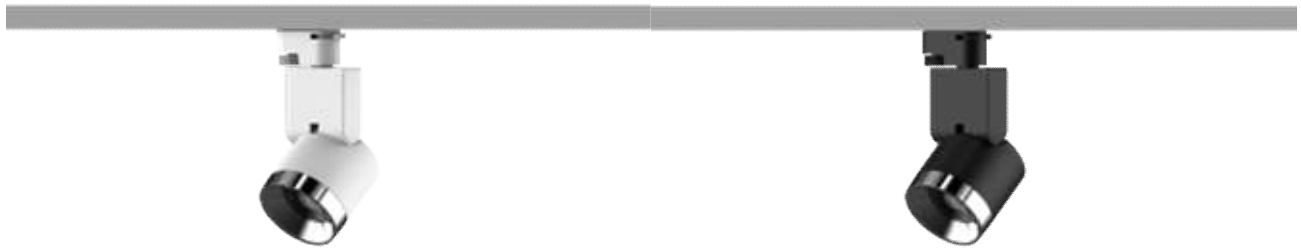

白銀(Ws)

黑銀(Bs)

Absolute Maximum Ratings at Ta=25 °C

Ta = 25°C時的絕對最大額定值

Parameter (參數)	Symbol 符號	Rating 範圍	Unit 單位
Operating Voltage (工作電壓)	V	AC100-240	V
Operating Temperature Range (工作溫度範圍)	Topr.	0 to +40	°C
Storage Temperature Range (存儲溫度範圍)	Tstg.	0 to +60	°C
Electric Static Discharge Threshold HBM(靜電放電臨界值)	ESD	6000	V
Operating Humidity (non – condensing)工作濕度(不凝結)	%	<80	RH

**Electrical And Optical Characteristics(光電特性表) :****BA15WBTTWxx01:**

Parameter 參數	Symbol 符號	Condition 條件	Min. 最小.	Typ. 平均	Max. 最大.	Unit 單位
Color Temperature (色溫)	CCT	220 VAC	2700	3000	3300	K
Color Index (演色性)	Ra		90	--	--	%
Power Consumption (消耗功率)	P _D		13.5	15	16.5	W
Power Factor (電源轉換效率)	PF		0.8	0.9	--	%
Flicker index (閃爍指數)	FI		--	--	0.02	--
Percent Flicker(閃爍百分比)	PF		--	--	2	%
Finished weight (整燈重量)			--	0.43	0.46	kg

Parameter 參數	Symbol 符號	Condition 條件	Min Angle 最小角度.	Max Angle 最大角度.	Unit 單位
Beam Angle 50%(光束角度)	$\Delta \theta$	220 VAC	25°	60°	Deg
Luminous Flux (光通量)	Φ_v		850±10%	1050±10%	lm
Illuminance @ 1M distance (1M 距離照度)			3300±10%	950±10%	Lux
Illuminance @ 1.5M distance (1.5M 距離照度)			1460±10%	420±10%	Lux
Illuminance @ 2M distance (2M 距離照度)			820±10%	230±10%	Lux
Illuminance @ 2.5M distance (2.5M 距離照度)			520±10%	150±10%	Lux
Illuminance @ 3M distance (3M 距離照度)			360±10%	100±10%	Lux

**BA15TBTTWxx01 :**

Parameter 參數	Symbol 符號	Condition 條件	Min. 最小.	Typ. 平均	Max. 最大.	Unit 單位
Color Temperature (色溫)	CCT	220 VAC	3700	4000	4300	K
Color Index (演色性)	Ra		90	--	--	%
Power Consumption (消耗功率)	P _D		13.5	15	16.5	W
Power Factor (電源轉換效率)	PF		0.8	0.9	--	%
Flicker index (閃爍指數)	FI		--	--	0.02	--
Percent Flicker(閃爍百分比)	PF		--	--	2	%
Finished weight (整燈重量)			--	0.43	0.46	kg

Parameter 參數	Symbol 符號	Condition 條件	Min Angle 最小角度.	Max Angle 最大角度.	Unit 單位
Beam Angle 50%(光束角度)	$\Delta \theta$	220 VAC	25°	60°	Deg
Luminous Flux (光通量)	Φ_v		950±10%	1200±10%	lm
Illuminance @ 1M distance (1M 距離照度)			3800±10%	1000±10%	Lux
Illuminance @ 1.5M distance (1.5M 距離照度)			1680±10%	440±10%	Lux
Illuminance @ 2M distance (2M 距離照度)			950±10%	250±10%	Lux
Illuminance @ 2.5M distance (2.5M 距離照度)			600±10%	160±10%	Lux
Illuminance @ 3M distance (3M 距離照度)			420±10%	110±10%	Lux

**BA15CBTTWxx01 :**

Parameter 參數	Symbol 符號	Condition 條件	Min. 最小.	Typ. 平均	Max. 最大.	Unit 單位
Color Temperature (色溫)	CCT	220 VAC	5300	5700	6100	K
Color Index (演色性)	Ra		90	--	--	%
Power Consumption (消耗功率)	P _D		13.5	15	16.5	W
Power Factor (電源轉換效率)	PF		0.8	0.9	--	%
Flicker index (閃爍指數)	FI		--	--	0.02	--
Percent Flicker(閃爍百分比)	PF		--	--	2	%
Finished weight (整燈重量)			--	0.43	0.46	kg

Parameter 參數	Symbol 符號	Condition 條件	Min Angle 最小角度.	Max Angle 最大角度.	Unit 單位
Beam Angle 50%(光束角度)	$\Delta \theta$	220 VAC	25°	60°	Deg
Luminous Flux (光通量)	Φ_v		950±10%	1200±10%	lm
Illuminance @ 1M distance (1M 距離照度)			3800±10%	1000±10%	Lux
Illuminance @ 1.5M distance (1.5M 距離照度)			1680±10%	440±10%	Lux
Illuminance @ 2M distance (2M 距離照度)			950±10%	250±10%	Lux
Illuminance @ 2.5M distance (2.5M 距離照度)			600±10%	160±10%	Lux
Illuminance @ 3M distance (3M 距離照度)			420±10%	110±10%	Lux



Radiation Diagram(配光曲線):

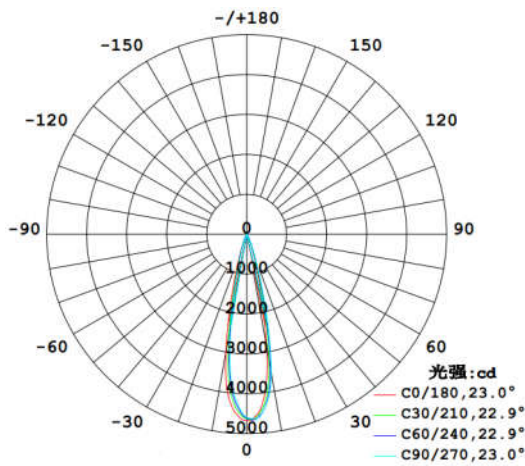

25 度

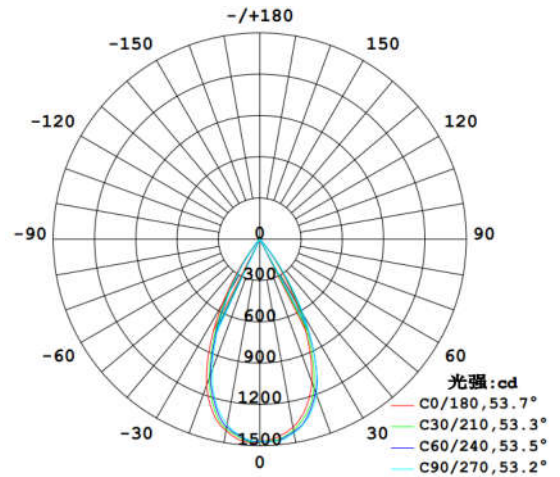

60 度

Label Description (標籤說明):

產品標籤:

Inner Box 內盒 貼紙尺寸(40*15mm)

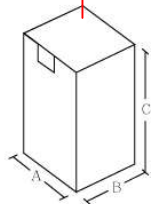

Energyled 委製商/進口商:華能光電科技股份有限公司
 地址:新北市新店區中正路542-4號6樓
 電話:02-77290589 一般室內照明用

燈具型號: BA15SBTTW0001
 額定電壓: 100-240VAC 50/60Hz
 額定電流: 0.17-0.06A
 額定功率: 15W PF:0.9@110/220
 光源型式: 不可更換COB LED 13.5W x 1
 商品原產地:
 產品批號:
 製造年份及製造號碼:

R35958
 RoHS
 ta:40°C

Part No.	A (mm)	B (mm)	C (mm)
BA15xBTTWxx01	86	80	172



Encased Type (包裝方式): **外箱標籤(70*40mm)**

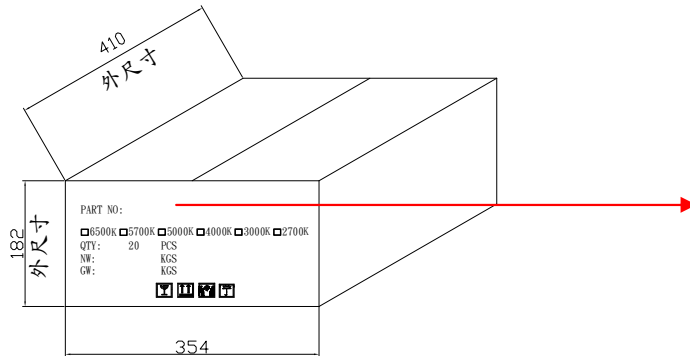
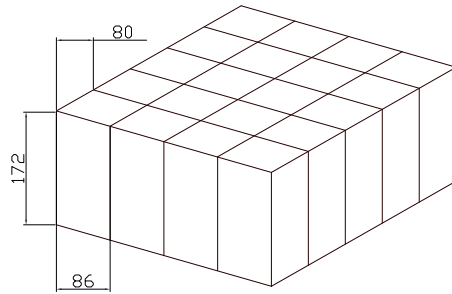

LED TRACK LIGHT
 INPUT:100-240V / 15W / 50/60Hz
 MODEL: BA15WBTTW0001
 COLOR: 3000K
 Qty: 20 PCS
 LOT No.:
 DATE: